



Calvary Baptist Church Newsletter, December 2017

What gift(s) has God placed in you at the time you trusted in Jesus as Lord and Savior? Please complete the Gifts Survey in the worship folders over the five Sundays I preached on the Gifts of the Spirit. I may just ask you from time to time to tell what you believe your gift to be.

Homecoming was awesome. A good number of people present and the kick off of a wonderful Revival. I hope you were as revived as I was by the time we spent with Roger and all the great music. Roger's challenge to us was right on target. We must assess where we are in the Kingdom. Are we just at church or are we with Jesus? There is a great difference. So many today just attend church and do nothing with what they hear and are challenged to do.

I was really warmed by the decisions made, especially the Three(3) who profess Christ publicly as Lord and Savior. Pray for these 3 young people as they are mentored/disciples by 3 of you. They are being led through an eleven week study on how to live the Christian Life.

Many of you may not have heard of the 16 year old young man who attended on Tuesday at the invitation of one of our Youth. Roger preached on God preparing folks to trust in His Son and guess what? This young man just blurted out to Roger that he needed someone to tell him how to be saved. Andy and I took him to the office and led him to accept Jesus as his Lord and Savior. We have some work to do to help him move to a public statement of his new faith.

How many are out there who want to hear the story of Jesus, but have no one to tell them. Each of us can tell our story to so many folks. God never told us we must be successful. He just told us to be faithful in telling the story. Wouldn't it wonderful to see 3-4 each month put their trust in Christ?

Christmas Eve in on Sunday evening this year. Plan now to have your whole family in worship for this special service with Lord's Supper. If you have visitors in your home, make it a part of your evening to bring them to this service. It will only last about 30 minutes. Let's pack the house of God at Calvary this Christmas Eve.

Your Transition Team is really working hard on Leadership and Decision Making Process for the church. Setting Goals and Objectives. Stating a Vision Statement and Mission Statement. These statements are important, because they say who you are and who you want to become. The church in business session must decide if they want to following the directions set before them by this Team. Pray for them and their work.

Carolyn and I thank you for the wonderful Pastor Appreciation gift of a night out at a Bed and Breakfast. We look forward to enjoying the time together. You are a gracious people and I want the whole world to know just how wonderful you are. So "Go Tell It On the Mountain, that Jesus Christ has Come."

In His Service,

Dan

Staff

Interim Pastor: Dan Agee

Cell- 540-483-1610

Email: pastor@cbcfloyd.org

Administrative Assistant: Tammy Bowen
Church Office Hours:

Tuesday—Thursday 8:00—1:00 p.m.
540-745-3744

E-Mail: cbcfloyd@swva.net

Web site: cbcfloyd.org

Worship Services and Activities

SUNDAY

9:30 a.m. Pastries and coffee in the fellowship hall

9:45 a.m. Sunday school opening in the Sanctuary

11:00 a.m. Morning Worship Service

Children's Church during Worship Service



WEDNESDAY

7:00 p.m. Bible Study

Prayer study group seeks to have the Church pray for "Unity and doing the will of God."



BIRTHDAYS THIS MONTH

Hershel Asbury
 Sherman Asbury
 Janie Blanchard
 Lyndall Bower
 Pat Bowling
 Jeanette Burnside
 Billy Burgess
 Arthur Conner
 Emmie Conner
 Melvin Compton
 Kendall Epperly
 B.L. Furrow

Wyatt Gearhart
 Donna Grant
 Russell Janney
 Jason Jenkins
 Charlotte Peters
 Wilma Sizer
 Cindy Urguhart
 Gene Weeks
 Wesley Winters
 Pat Whitlock
 J.J. Whitt

December 10—David Graham
December 19—Keith Young
December 31—Robert Hatcher
December 31—Linda Huff



Women's Bible Study
 There will be
 no
 Women's Bible
 Study in December.

Carol Vaughn, Leader

~ Mountain Topper News ~

Calvary's Mountain Toppers will be going to Thomas Road Baptist Church in Lynchburg to see the Christmas Spectacular on Saturday, December 2, We will be leaving the church at 10:30 a.m. We will be going to the 2:00 show and we will have dinner after the show.

Missions at a Glance

Missions start at home. That's been the focus for the Friends & Food program at Calvary Baptist for some time. It's one way we reach out to our community to supplement their home pantries and provide spiritual nourishment on a monthly basis. Three Wednesdays each month finds volunteers giving Bakery Blessings to those who need breads, pastries and other deli items donated by Food Lion each day. We are blessed with fine, dedicated people to carry out these programs but volunteers are continually needed to help serve others. Calvary Baptist also supports missions through giving to state, national and international missions boards. In September we just completed our yearly Alma Hunt offering to the joint venture of Women's Missionary Union of Virginia (WMUV) and the Baptist General Association of Virginia (BGAV). This offering goes to **Virginia** Baptists' outreach projects and special ministries. We'll next take the Lottie Moon Christmas Offering in December for the International Missions Board (IMB) which partners with Southern Baptist churches. It's the IMB's goal to reach people on every part of our planet who are unaware, unengaged, unreached and uncontacted about our Lord and Savior Jesus Christ. Lastly, Calvary Baptist donated to the Annie Armstrong Easter Offering which is a joint venture of the Women's Missionary Board (WMU) and the North American Missionary Board (NAMB). These offering dollars go to missionaries who work to share the gospel all through the United States and Canada. People of all size, age, color and race need Jesus. He carried our sin to the cross. Now it's our turn to let others know about His mercy and grace here at home and beyond the borders of Floyd County.

~ Pamela Rumburg, Friends & Food Director

Lottie Moon Christmas Offering

Lottie Moon served as a missionary in China over 100 years ago. During her tenure there she wrote letters to the churches of America challenging them to not only send more but also financially support missionaries to the Chinese people. The International Missions Board (IMB) honors Lottie by naming their annual offering as a tribute to her amazing witness for God.

Today cities and towns are globally becoming increasingly more diverse. How do missionaries keep up? They're meeting people where they are, making connections, and offering Jesus Christ as "the Way, the Truth, and the Life."

We know in our hearts that there are unreached souls all over the world. Your contribution to the IMB Lottie Moon Christmas Offering provides the means and support for God's Word to be spread to people who have never heard the gospel. Think about it. We're changing lives. Forever.

Kid's Corner



POP-UP CARD

Share the good news of Jesus' birth with this creative Christmas card.

What you need:

- Construction paper (two pieces, including one white)
- Pencil
- Scissors
- Pens
- Glue stick

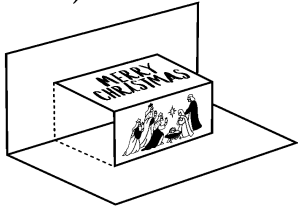

What you do:

1. Neatly fold the white paper in half, short side to short side.
2. Draw two parallel lines (at least 2 inches apart) from the fold to about halfway to the edge. Cut along the lines.
3. Fold the cut section back and forth so it pops up.
4. Push the section up so it pops up inside the folded paper. Draw a nativity scene on the pop-up box.
5. Fold the colored paper in half, short side to short side. Place the white paper inside it and glue the white paper down, being careful not to glue the pop-up box.
6. Write a Christmas message and give or send the card to someone.

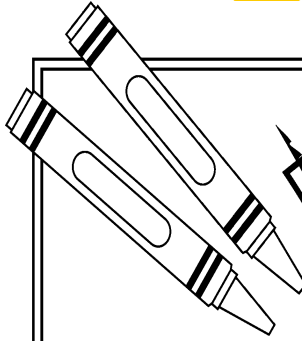

PUZZLE

JOURNEY TO

BETHLEHEM

In the Christmas story in Luke 2, an angel tells some shepherds to go see baby Jesus in Bethlehem.



START



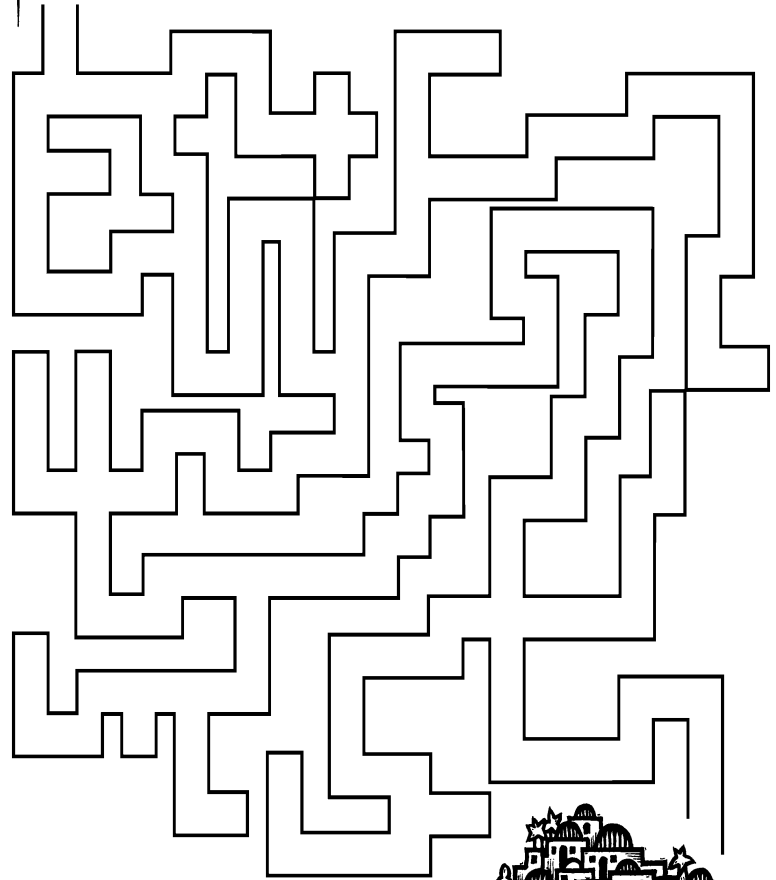







Directions: Follow the maze to arrive in Bethlehem.



BETHLEHEM



* Calvary Baptist Church Calendar December 2017 *

Sun	Mon	Tue	Wed	Thu	Fri	Sat
					1	2  10:30 a.m. Mountain Toppers trip to Thomas Road Christmas Spectacular
3 Sounds Of Harmony Lord's Supper Church Council Meeting following morning worship Deacons' Meeting after Church Council	4	5	6  7:00 p.m. Business Meeting	7	8	9 Fellowship Hall Reserved
10  Teresa Epperly	11	12  All Newsletter Articles are Due!	13  7:00 p.m. Bible Study	14	15	16
17  Andy Bandy Christmas Dinner	18	19	20  No Bible Study	21  6:00 p.m. Friends and Food	22	23
24  9:00 p.m. Christmas Eve Service	25  MERRY CHRISTMAS	26	27  7:00 p.m. Bible Study	28	29	30
31  Deb Funkhouser Youth Winter Fest						

Calvary Baptist Church
1400 Floyd Hwy. N
Floyd, Virginia 24091